

Maguval

creativo

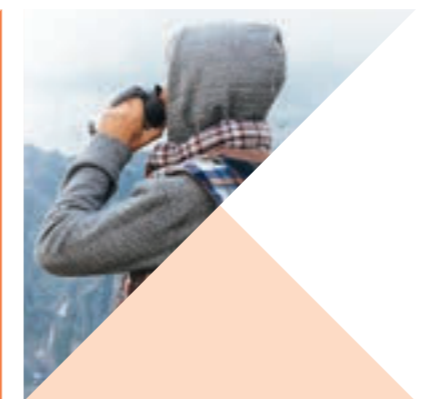



Termos y Cilindros



HANNAH

T 53

Botella de acero inoxidable con detalle de bambú en tapa Cap. 750ml



- MT Acero Inox
- M 25 x 7 cm
- E 60 Pzas
- MI 16 x 6 cm
- TI Serigrafía / Láser / Tampografía



KENUX

T 23

Termo de acero inoxidable de doble pared, tapa que evita derrames, cuenta con candado de seguridad en la boca de la botella. Cap. 500 ml.

- MT Acero Inox / Plástico
- M 23.5 x 6.5 cm
- E 50 Pzas
- MI 10 x 4 cm
- TI Serigrafía / Láser / Tampografía

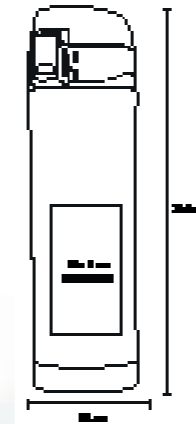



URANO

T 67



Botella térmica con doble pared de acero inoxidable, que mantiene tus bebidas calientes y frías por más tiempo. Con tapa enroscable. Cap. 500 ml

- MT Acero Inox. 23 x 7 cm
- M 60 Pzas
- MI 11 x 9 cm
- TI Serigrafía / Láser / Tampografía

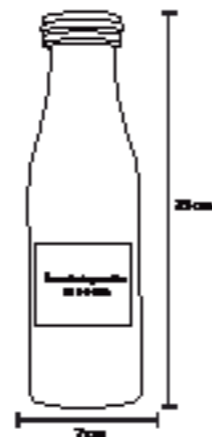

TERBUX

T 27

Termo de acero inoxidable, doble pared. Interior en acero, cuenta con boquilla de seguridad. Cap. 500 ml.

- MT Acero Inox. / Plástico 20,5 x 8,5 cm
- M 36 Pzas
- MI 10 x 4,5 cm
- TI Serigrafía / Láser / Tampografía

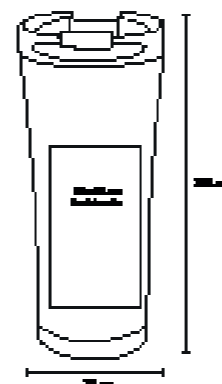



TIBET T 57



Botella térmica con doble pared de acero inoxidable, que mantiene tus bebidas calientes y frías por más tiempo. Con tapa enroscable. Cap. 550 ml

- MT Acero Inox.
- M 25.5 x 6.5 cm
- E 50 Pzas
- MI 4.5 x 11 cm
- TI Serigrafía / Tampografía / Láser

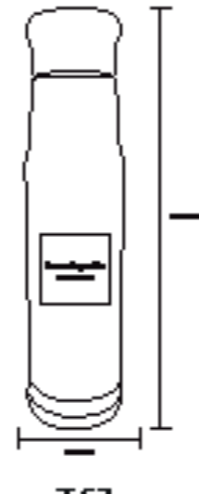

MORIK T 32

Termo con doble pared de acero inoxidable y tapa que funciona como taza. Cap. 500 ml

- MT Acero Inox / Plástico
- M 25 x 6.7 cm
- E 50 Pzas
- MI 14 x 7 cm
- TI Serigrafía / Láser / Tampografía

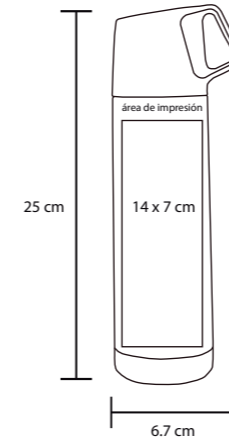



GEM

T 44

Termo con doble pared de acero inoxidable, tapa hermética enroscable y botón para evitar derrames. Cap. 450 ml.

- MT Acero Inox / Plástico
- M 218 x 7 cm
- E 60 Pzas
- MI 18 x 6 cm
- TI Serigrafía / Láser / Tampografía



YAREN

T 63

Termo de doble pared de acero inoxidable con acabado mate y correa para sujetar. Cap. 380 ml.

- MT Acero Inox.
- M 23 x 6 cm
- E 60 Pzas
- MI 13 x 6 cm
- TI Serigrafía / Tampografía / Láser

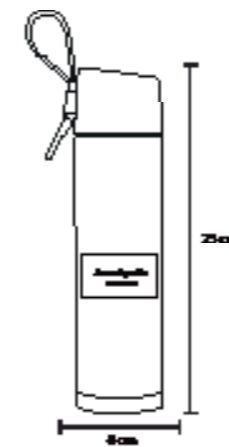

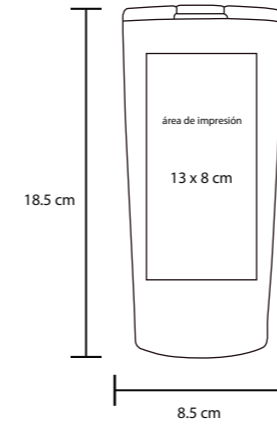

DUVA

T 35

Termo de alta tecnología con doble pared de acero inoxidable que mantiene tus bebidas calientes y frías por más tiempo. Incluye tapa de presión transparente. Cap. 500 ml.

MT Acero Inox. / Plástico M 18.5 x 8.5 cm E 50 Pzas

MI 13 x 8 cm TI Serigrafía / Láser / Tampografía



MAK

T 34

Termo de alta tecnología con doble pared de acero inoxidable, que mantiene tus bebidas calientes y frías por más tiempo. Incluye tapa de presión transparente. Cap. 870 ml.

MT Acero Inox. / Plástico M 23 x 10 cm E 50 Pzas

MI 10 x 7.5 cm TI Serigrafía / Láser / Tampografía

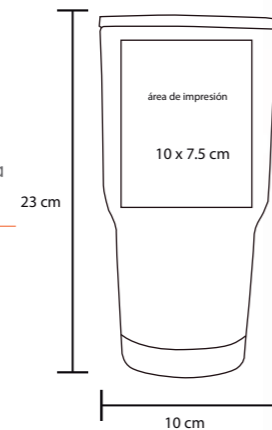



FROSY

T 58



Termo difuminado con doble pared de acero inoxidable que mantiene tus bebidas calientes y frías por más tiempo. Incluye tapa de presión transparente. Cap. 500 ml.

- MT Acero Inox. M 18.5 x 8.5 cm E 50 Pzas
- MI 13 x 8 cm TI Serigrafía / Láser / Tampografía

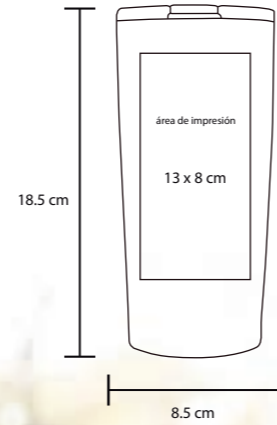

MIKA

T 47

Termo con doble pared de acero inoxidable, tapa hermética enroscable y botón para evitar derrames. Cap. 450 ml.

- MT Acero Inox. / Plástico M 19.7 x 8.5 cm E 48 Pzas
- MI 6 x 4 cm TI Serigrafía / Láser / Tampografía

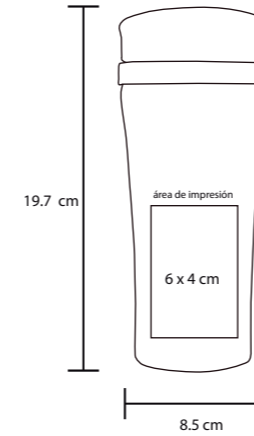

VETTEL

T 24

Termo de doble pared con mango de plástico, interior de acero inoxidable. Incluye en la parte inferior un chupón para fijarlo a una superficie. Cap. 400 ml

- MT Acero Inox. / Plástico M 19.5 x 9 cm E 36 Pzas
- MI 5 x 5 cm TI Serigrafía / Láser / Tampografía

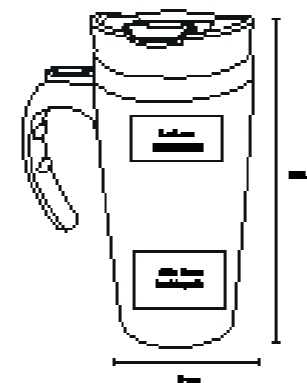

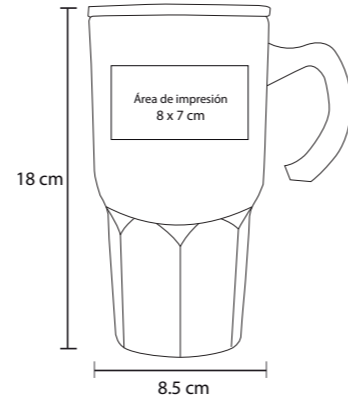

MAYKON

T 62

Termo con doble pared con interior de plástico, con tapa de cierre a presión. Cap. 500 ml

MT Acero Inox. / Plástico M 25 x 6.7 cm E 24 Pzas
MI 14 x 7 cm TI Serigrafía / Láser / Tampografía



NILO

T 25

Termo con doble pared de plástico, con mango y boquilla de seguridad. Cap. 500 ml

MT Acero Inox. / Plástico M 19.5 x 8.5 cm E 40 Pzas
MI 10 x 5 cm TI Serigrafía / Láser / Tampografía

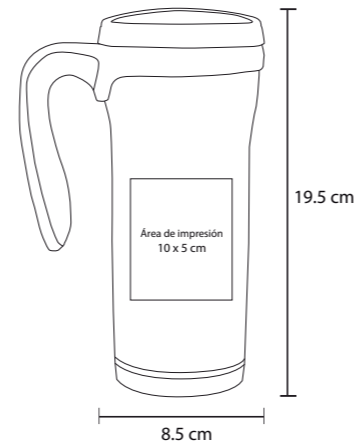

KOBE

T 65

Termo con doble pared de acero inoxidable con tapa de cierre a presión. Cap. 500 ml

MT Acero Inox. / Plástico M 18 x 9 cm E 24 Pzas MI 8 x 8 cm TI Serigrafía / Láser Tampografía

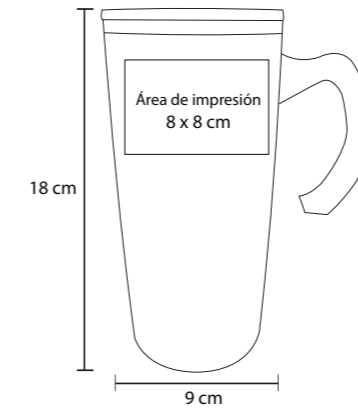

TIGUAN

T 28

Termo de acero inoxidable con mango e interior de plástico, incluye tapa con rosca que evita derrames y boquilla de seguridad. Cap. 500 ml

MT Acero Inox. / Plástico M 21 x 8.5 cm E 40 Pzas
MI 10 x 6 cm TI Serigrafía / Láser / Tampografía





HASEN

T 51



Termo ergonómico de doble pared con interior de acero inoxidable y exterior acabado rubber, tapa enroscable y boquilla con seguro. Cap.450ml

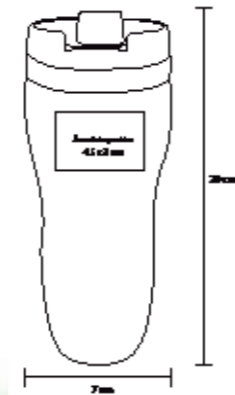

- MT Acero Inox. / Plástico
- M 20 x 7 cm
- E 60 Pzas
- MI 4,5 x 3 cm
- TI Tampografía



KRAKE

T 39

Termo ergonómico con doble pared de acero inoxidable, tapa enroscable y boquilla con seguro. Cap. 450 ml.

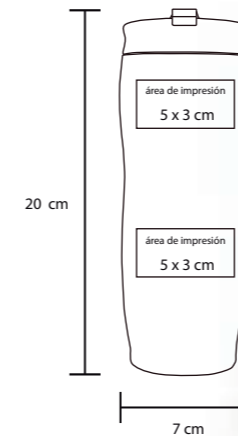

- MT Acero Inox. / Plástico
- M 20 x 7 cm
- E 48 Pzas
- MI 5 x 3 cm
- TI Serigrafía / Láser / Tampografía





PRINCESS

T 55

Termo de acero inoxidable con interior de plástico. Tapa de rosca. Cap. 450 ml

- MT Acero Inox. / Plástico
- M 18,5 x 7 cm
- E 60 Pzas
- MI 5 x 4 cm
- TI Láser / Tampografía

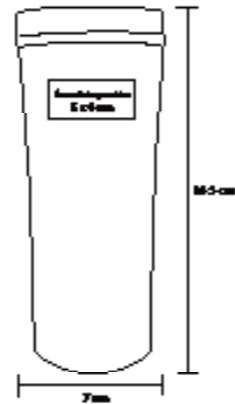

TOG

T 45

Termo de doble pared con interior de plástico, tapa enroscable y válvula de seguridad. Cap. 450 ml.

- MT Acero Inox. / Plástico
- M 21,8 x 7 cm
- E 60 Pzas
- MI 6 x 5 cm
- TI Serigrafía / Láser / Tampografía

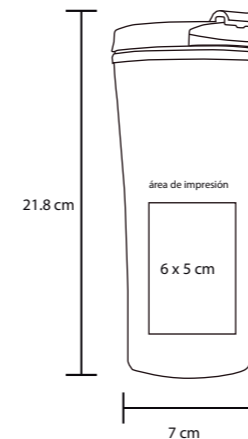



REQ

T 37

Termo ergonómico de doble pared interior de plástico y tapa enroscable. Cap. 450 ml.

- MT Acero Inox. / Plástico
- M 19.5 x 8 cm
- E 48 Pzas
- MI 8 x 6 cm
- TI Serigrafía / Láser / Tampografía



CALI

T 01

Termo de acero inoxidable con mango e interior de plástico, incluye tapa con rosca que evita derrames y boquilla de seguridad. Cap. 500 ml

- MT Acero Inox. / Plástico
- M 17 x 8 cm
- E 40 Pzas
- MI 7 x 5 cm
- TI Serigrafía / Láser / Tampografía



YUKON

T 56

Taza térmica con doble pared de acero inoxidable y asa de plástico. Cap. 250 ml

- MT Acero Inox.
- M 10.5 x 8 cm
- E 50 Pzas
- MI 4 x 5 cm
- TI Láser / Tampografía

Nuevo

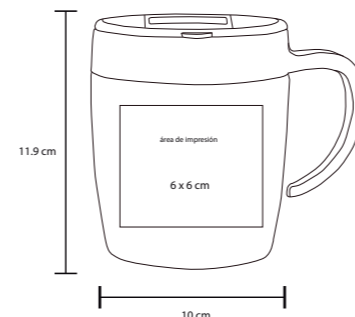

EVIN

T 46

Tarro térmico con doble pared de acero inoxidable, tapa enroscable, asa de plástico y válvula de seguridad. Cap. 450 ml.

- MT Acero Inox. / Plástico
- M 11.9 x 10 cm
- E 48 Pzas
- MI 6 x 6 cm
- TI Serigrafía / Láser / Tampografía



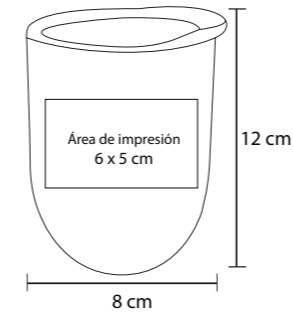
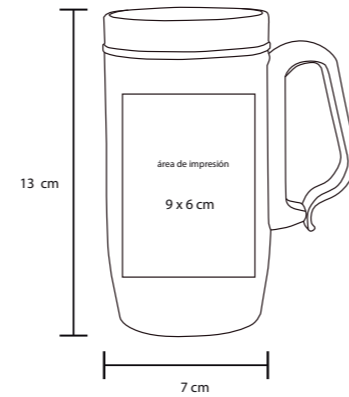

KORALE

T 31

Taza térmica con doble pared de acero inoxidable y asa de plástico. Cap. 250 ml

MT Acero Inox. / Plástico M 13 x 7 cm E 48 Pzas
MI 9 x 6 cm TI Serigrafía / Láser / Tampografía



CARSON

T 64

Taza de doble pared de acero inoxidable, con tapa de cierre a presión transparente. Cap. 300 ml

MT Acero Inox. M 12 x 8 cm E 30 Pzas
MI 6 x 5 cm TI Serigrafía / Láser / Tampografía





CERÁMICA

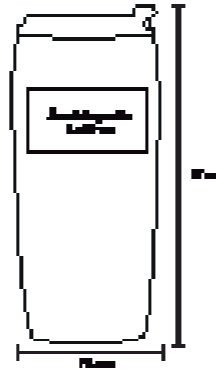

LORETO

T 61

Termo de cerámica con tapa de plástico.
Cap. 400 ml

MT Cerámica M 17 x 7.5 cm E 72 Pzas

MI 6 x 10 cm TI Serigrafía / Tampografía / Sand Blast



TOWER

TB 500

Termo de acero inoxidable con interior metálico, válvula de seguridad y tapa que se utiliza como vaso. Cap. 500 ml

MT Acero Inox. M 24 x 6.6 cm E 50 Pzas

MI 15 x 4 cm TI Serigrafía / Láser / Tampografía

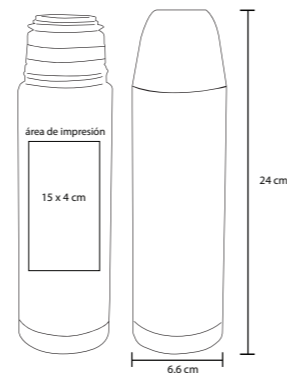

MUG

T 21



Termo de plástico con cintilla de color
Cap. 500 ml

MT Plástico M 17.8 x 9 cm E 40 Pzas

MI 5 x 17 cm TI Serigrafía / Tampografía

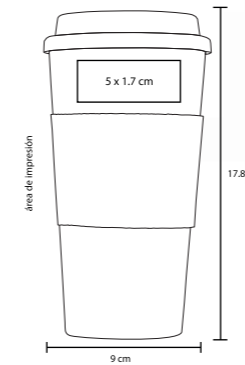

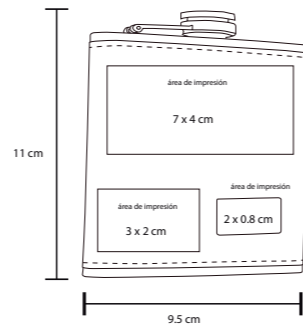

TUNO

T 43

Set de licorera que incluye embudo y caja de regalo. Cap 6 Oz.

MT Acero Inox. / Curpiel M 11 x 9.5 cm E 100 Pzas

MI 7 x 4 cm TI Serigrafía / Láser / Tampografía

LYON

T 42

Set de licorera que incluye 2 vasos metálicos, embudo y caja de regalo. Cap 8 Oz.

MT Acero Inox. / Curpiel M 13.5 x 9.5 cm E 60 Pzas

MI 9 x 7 cm TI Serigrafía / Láser / Tampografía

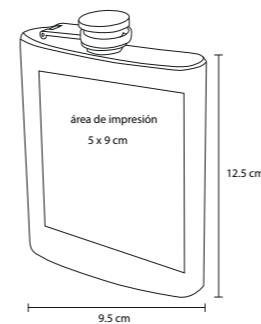
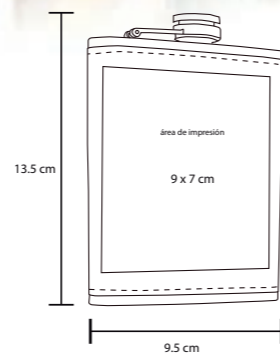

MARCUS

T22

Licorera de bolsillo de acero inoxidable con tapa enroscable. Ideal para viajes. Cap. 7 oz

MT Acero Inox. M 12.5 x 9.5 cm E 100 Pzas

MI 5 x 9 cm TI Serigrafía / Láser / Tampografía





MINSK



T 60

Vaso de cerámica con tapa y popote metálico. Cap. 400 ml.

MT Cerámica / Acero Inox. M 13.5 x 8 cm E 60 Pzas

MI 8 x 10 cm TI Serigrafía / Tampografía / Sand Blast

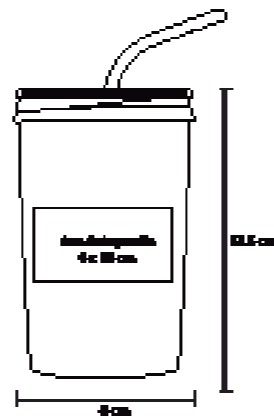

CERÁMICA

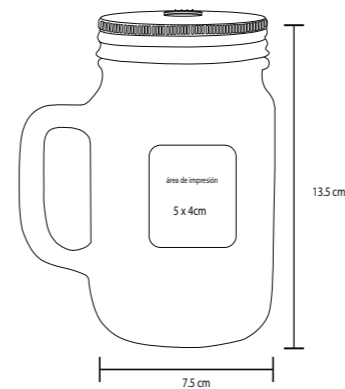

ABELO

T 40

Tarro de vidrio con asa. Tapa metálica. Incluye popote rígido. Cap. 400 ml.

MT Vidrio M 13.5 x 7.5 cm E 48 Pzas

MI 5 x 4 cm TI Serigrafía / Tampografía / Sand blast



BEER

T 41

Tarro cervecero de vidrio con asa. Cap. 360 ml.

MT Vidrio M 14.5 x 7.5 cm E 36 Pzas

MI 6 x 7 cm TI Serigrafía / Tampografía / Sand blast

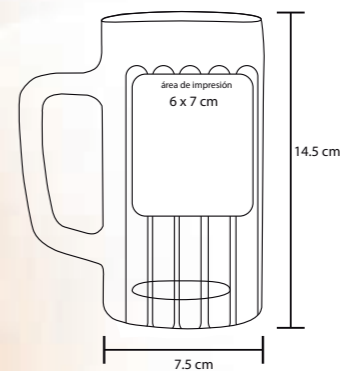

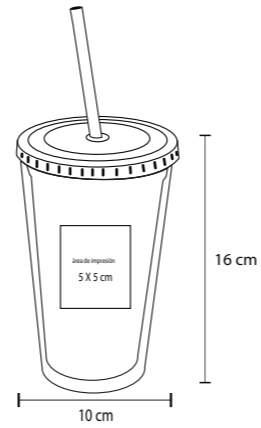

TROPICAL

T 48T



Vaso de doble pared de plástico con popote Cap. 500 ml.

MT Plástico M 16 x 10 cm E 48 Pzas MI 5 x 5 cm TI Serigrafía / Tampografía



RUBIN

T 36

Botella plástica en forma de garrafa de color transparente con tapa de rosca. Cap. 380 ml.

MT Plástico M 215 x 12,7 cm E 36 Pzas MI 12 x 8,5 cm TI Serigrafía / Tampografía

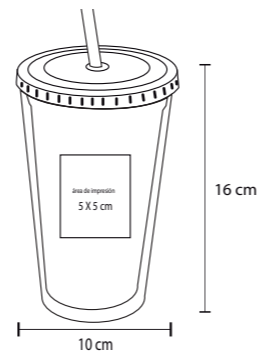

HABANA

T 66



Vaso de doble pared de plástico con popote Cap. 500 ml.

MT Plástico M 16 x 10 cm E 48 Pzas MI 5 x 5 cm TI Serigrafía / Tampografía

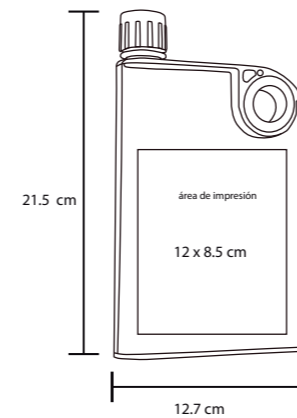

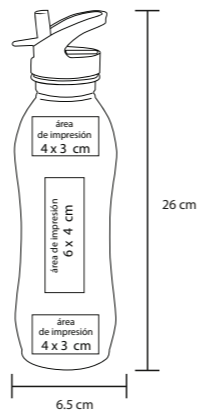

ZURICH

T 07

Cilindro de acero inoxidable con boquilla y popote Cap. 750 ml

MT Acero inox. M 26 x 6.5 cm E 60 Pzas. MI 6 x 4 cm TI Láser / Tampografía



CITLALI

T 52

Termo de acero inoxidable con cintilla de silicón Cap. 600 ml.

MT Acero Inox. / Plástico M 25 x 6.5 cm E 60 Pzas

MI 5 x 7 cm TI Serigrafía / Láser / Tampografía

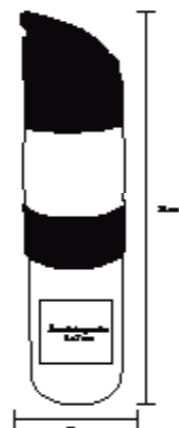

ENZO

T 29

Cilindro de plástico con chupón, banda de silicón y tapa que sirve como vaso Cap. 700 ml

MT Plástico M 29.7 x 7.2 cm E 32 Pzas

MI 12 x 7 cm TI Serigrafía / Tampografía

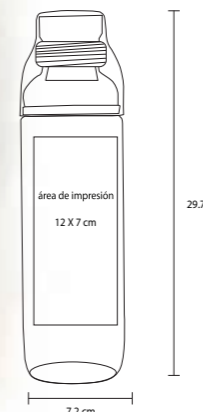



DRYSOR

T 38

Cilindro de plástico transparente con tapa de rosca, popote con protector y seguro. Incluye correa de mano. Cap. 420 ml.

- MT Plástico
- M 23 x 7.1 cm
- E 80 Pzas
- MI 13 x 10 cm
- TI Serigrafía / Tampografía



ANTARA

T 11

Cilindro de plástico con tapa, manga y cordón Cap. 600 ml

- MT Plástico
- M 22.5 x 7.5 cm
- E 80 Pzas
- MI 7 x 5 cm
- TI Serigrafía / Tampografía

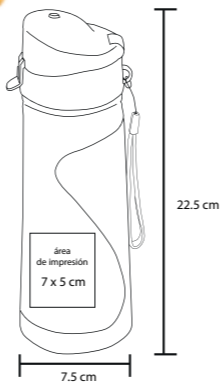

GYM

T 18

Cilindro de plástico con compartimientos, resorte de acero y colador. Cap. 450 ml

- MT Plástico
- M 21.5 x 10 cm
- E 72 Pzas
- MI 5 x 4 cm
- TI Serigrafía / Tampografía





TIREX

Nuevo

T 59

Cilindro de plástico, tapa enroscable con correa para sujetar y apertura central para permitir un mejor lavado. Cap. 600 ml.

MT Plástico M 23 x 7 cm E 60 Pzas

MI 12 x 5.5 cm TI Serigrafía / Tampografía



Capacidad 1 litro Ideal para tu consumo mínimo de agua



ROCKY

T 20

Cilindro de plástico con boquilla y agarradera. Cap. 1 litro

MT Plástico M 26 x 9.5 cm E 40 Pzas

MI 12 x 12 cm TI Serigrafía / Tampografía



COSMOS

T 26

Vaso tipo frozen de doble pared con asa de plástico. Incluye un compartimento en la tapa para guardar algún suplemento o polvo. Cap. 400 ml

MT Plástico M 18.3 x 7.5 cm E 72 Pzas

MI 5 x 4 cm TI Serigrafía / Tampografía

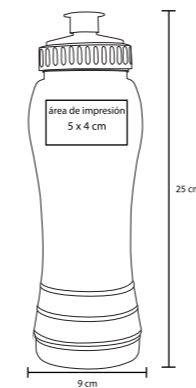

POP

T 19

Cilindro de plástico de color traslúcido con chupón Cap. 750 ml

MT Plástico M 25 x 9 cm E 50 Pzas MI 5 x 4 cm TI Tampografía





CALIFORNIA

T 16

Cilindro de plástico con tapa enroscable
Cap. 550 ml

MT Plástico M 24,5 x 6,5 cm E 60 Pzas.

MI 5 x 7 cm TI Serigrafía / Tampografía

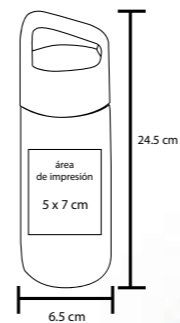
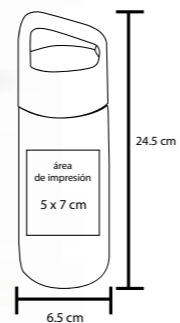

CHICAGO

T 17

Cilindro de plástico con tapa enroscable
Cap. 550 ml

MT Plástico M 24,5 x 6,5 cm E 60 Pzas.

MI 5 x 7 cm TI Serigrafía / Tampografía



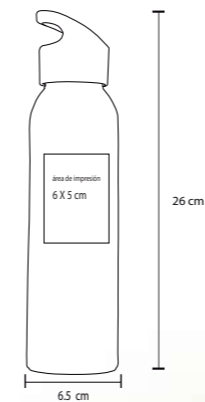

LAYS

T 50

Cilindro de plástico con asa sujetadora
Cap. 800 ml.

- MT Plástico
- M 26 x 6.5 cm
- E 40 Pzas
- MI 6 x 5 cm
- TI Serigrafía / Tampografía



DINAMO

T 48

Cilindro de plástico con popote y asa sujetadora
Cap. 800 ml.

- MT Plástico
- M 23.5 x 7.5 cm
- E 38 Pzas
- MI 5.5 x 5.5 cm
- TI Serigrafía / Tampografía

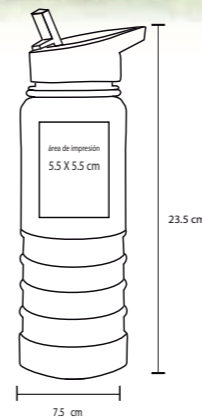

GARMIN

T 49

Cilindro de plástico con asa sujetadora
Cap. 800 ml.

- MT Plástico
- M 25 x 7.5 cm
- E 40 Pzas
- MI 12 x 7 cm
- TI Serigrafía / Tampografía





IRON

T 30



Cilindro squeeze de color solido con chupón ideal para carreras y competencias. Cap. 550 ml.

MT Plástico M 20,5 x 7,3 cm E 40 Pzas

MI 7 x 6 cm TI Serigrafía / Tampografía



BITROK

T 71



Cilindro squeeze de color sólido con chupón ideal para carreras y competencias. Cap. 720 ml.

MT Plástico M 24 x 6 cm E 50 Pzas

MI 5,5 x 6 cm TI Serigrafía / Tampografía





IBIZA

T 68

Cilindro de plástico de doble pared con popote y boquilla Cap. 600 ml.

- MT Plástico
- M 26 x 8 cm
- E 50 Pzas
- MI 7 x 9 cm
- TI Serigrafía / Tampografía

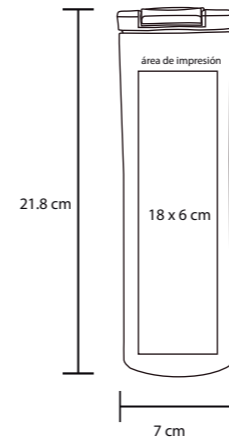
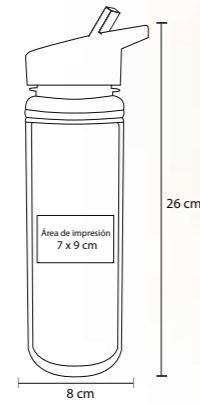

MELT

T 70

Termo de plástico con doble pared, tapa enroscable y válvula de seguridad. Cap. 500 ml.

- MT Plástico
- M 218 x 7 cm
- E 50 Pzas
- MI 18 x 6 cm
- TI Serigrafía / Tampografía

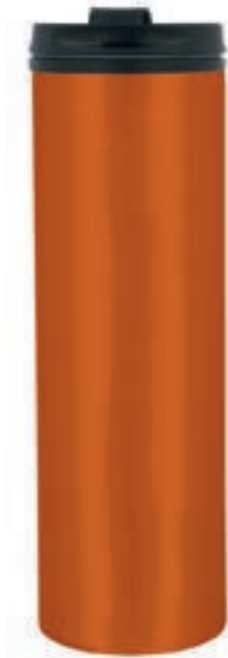



Calle Prolongación Zacatecas # 330,
Col. Barrio de Santiago. San Luis Potosí, S.L.P.

Estudio: (444) 305.82.18
contacto@nagualcreativo.com
nagualcreativo@gmail.com

www.nagualcreativo.com